

## DESCRIPTION

The emergency LED driver is the best backup for flush mount series when power outage happened suddenly. The battery could support the **6" Disk Light, 7" Flush Mount** working at least 90 minutes. Once the power restore, the driver will switch to the charging mode automatically. Ideal for hospitals, offices, schools, universities, shopping malls and other public buildings.

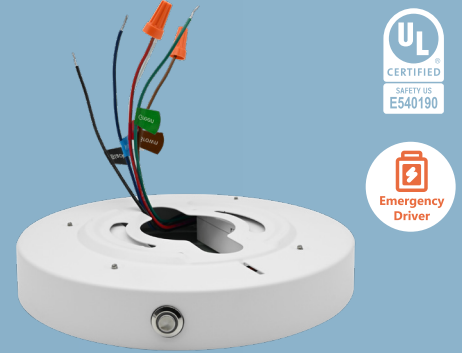

## TECHNICAL SPECIFICATION

MODEL	<b>EMSM-M15P13-B</b>
ADAPTIVE POWER	<b>15W Max</b>
EMERGENCY POWER	<b>13W</b>
INPUT VOLTAGE	<b>AC 120V</b>
OUTPUT VOLTAGE	<b>≤ AC 100V</b>
POWER FREQUENCY	<b>60Hz</b>
BATTERY CAPACITY	<b>3300mAh</b>
EMERGENCY TIME	<b>90 Minutes</b>
INITIAL CHARGE TIME	<b>24 Hours</b>
COMPATIBLE LAMP TYPE	<b>Flush Mount</b>
IP RATING	<b>IP20</b>
LED INDICATOR	<b>Red indicator</b>
BATTERY TYPE	<b>Li-ion</b>
COLOR	<b>White</b>
DIMENSIONS	<b>Φ189 * H28mm</b>
NET WEIGHT	<b>786g</b>
OPERATING TEMP	<b>(32°F~ 122°F) 0~50°C</b>
WARRANTY	<b>5 years</b>

## FEATURES

- Directly connect to AC Input of LED Fixtures.
- Includes 2-in 1 test switch and charge indicator light
- Support surface mount; Fit 2.75 and 3.5 inch J-Box;

## SWITCH TEST

1. Emergency conversion Kit will go into emergency mode if test switch is pressed when main supply is on, while it will go into charging mode if test switch is not pressed.
2. In emergency mode, press the test switch for 3 seconds to turn off the current emergency state.

## INDICATOR LIGHT

1. Red stable: charging mode or charging full.
2. Red off: mains power off or discharging mode.

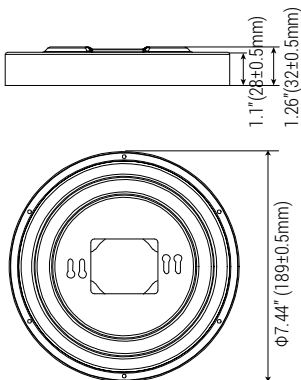

## Operation

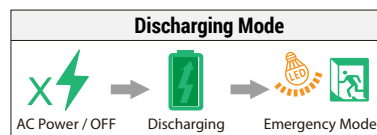
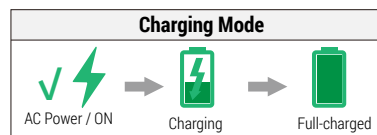

## Instruction light

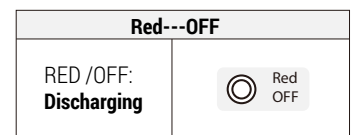
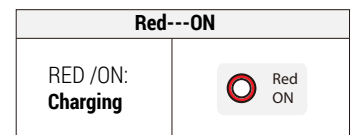

Catalog Number :      Project Name :      Note :      Date :      Type :

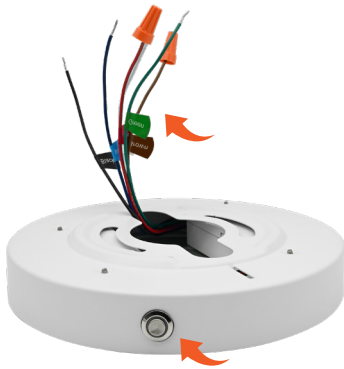

Includes 2-in 1 test switch and charge indicator light

**Input wire**

Red: A.C.Line(24/7)  
 White: Neutral  
 Black: A.C.Line Switch  
 Green: Ground

**Output wire**

Brown: A.C.Line(24/7)  
 Blue: Neutral

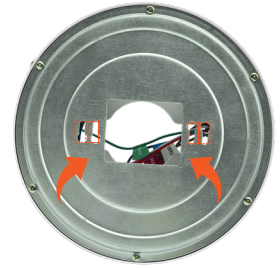

□ 2.75" Junction Box installation hole  
 □ 3.5" Junction Box installation hole

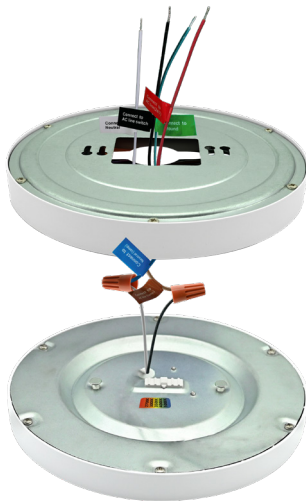

1. Do not mate connector until installation is complete and ac power is supplied.
2. Test accessory leads-observe proper polarity wiring.
3. This Emergency Battery Backup is not suitable for lamp with Sensor or Triac Dimmable.

**CAUTION:** RISK OF SHOCK-disconnect emergency and normal input power sources before servicing.

**ASSEMBLY and FIELD INSTALLATION WIRING:**

**WARNING:** AC power must be off before proceeding with assembly or installation of emergency driver.

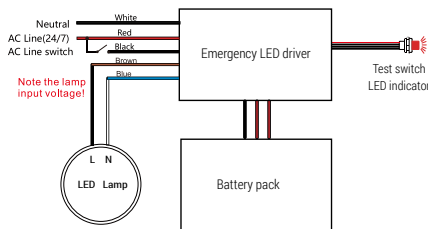

**IMPORTANT:**

- An un-switched AC power source is required(120Vac).It is designed for fixtures listed for dry and damp locations.
- Customers are advised to charge emergency LED driver 24 hours every 6 months during storage.

**CAUTION:**

- Make sure all electrical connections conform to the National Electrical Code and all applicable local regulations.
- This is a sealed unit. Components are not replaceable. Replace the entire LED Emergency Backup unit when necessary.
- Equipment should be mounted in locations and at heights where it is not be subjected to tampering by unauthorized personnel.
- The use of accessory equipment is not recommended by the manufacturer and may cause an unsafe condition.
- Use with grounded, UL Listed, dry or damp location rated fixtures. Case should also be grounded.
- Battery is rechargeable Li-ion type and must be recycled or disposed of properly.
- Suitable for use in 0°C -50°C ambient temperatures.
- This product is for use in indoor fixtures only. Do NOT use near heated air handling outlets or hazardous locations. Do not let power supply cords touch hot surfaces, Do not mount near gas or electric heaters. Do not use this equipment for other than its intended use. Failure to follow this may cause an unsafe condition and will void warranty. Servicing of this equipment should be performed by qualified personnel only.